



Hardware Manual for eNet-1553



Part Number: 151B1-00000-A13
Cage Code: 4RK27 • NAICS: 334210

Alta Data Technologies LLC
4901 Rockaway Blvd, Building A
Rio Rancho, NM 87124 USA
(tel) 505-994-3111 • www.altadt.com

CUSTOMER NOTES:

Revision Control History

Rev A13

Release Date: 17 January 2023

Note to the Reader and End-User:

This document is provided for information only and is © Alta Data Technologies LLC 2011-2023. While Alta strives to provide the most accurate information, there may be errors and omissions in this document. Alta disclaims all liability in document errors and any product usage. By using an Alta product, the customer or end user agrees (1) to accept Alta's Standard Terms and Conditions of Sale, Standard Warranty and Software License and (2) to not hold Alta Members, Employees, Contractors or Sales & Support Representatives responsible for any loss or legal liability, tangible or intangible, from any document errors or any product usage.

The product described in this document is not US ITAR controlled. Use of Alta products or documentation in violation of local usage, waste discard and export control rules, or in violation of US ITAR regulations, voids product warranty and shall not be supported. This document may be distributed to support government programs and projects. Third party person, company or consultant distribution is not allowed without Alta's written permission.

AltaCore, AltaCore-1553, AltaCore-ARINC, AltaAPI, AltaView and *AltaRTVal* are Trademarks of Alta Data Technologies LLC, Rio Rancho, New Mexico USA

Contact:

We welcome comments and suggestions. Please contact us at 888-429-1553 (toll free in US) or 505-994-3111 or visit our web site for support submit forms at www.altadt.com.

eNet-1553

Table of Contents

eNet-1553	iii
Table of Contents	iii
eNet-1553 Hardware Manual	1
Introduction.....	1
ESD and General Handling of Computer Interface Cards	2
eNet-1553 Description.....	2
Card Level Specifications.....	3
Power Specifications	4
Table 1. Idle Power	4
Table 2. 50% Bus Loading Power	4
Table 3. 95% Bus Loading Power	4
eNet-1553 Power and Ethernet Speed Negotiation:	4
MTBF	4
Table 4. MTBF	4
eNet-1553 Photograph	5
LED Descriptions	5
Table 5. LED Descriptions	5
eNet-1553 Dimensions.....	6
Factory Default IP V4 Address	7
How to Reset IP Address to Factory Default	7
MAC Address:	7
Signal Capture Discussion	8
Host Memory Map	9
eNet-1553 Global Registers	9
Revision Information.....	10
Appendix A eNet-1553 Connectors and Cable Assembly Information	11
J1 and J2 Connector Information – Alta & Glenair (GA) Part Numbers	11
J1 and J2 Pin-Out Table	12
Optional J1 and J2 Cable Assemblies	13

Figure A-1: Optional ENETCAB-1553-J1-01 Cable Assembly	13
ENETCAB-1553-J1-01 Cable Assembly Notes:	14
Table A-1: Over-Molded Ethernet RJ-45 Jack Pin-Outs.....	14
Figure A-2: Optional ENETCAB-J2-01 Cable Assembly	15
ENETCAB-J2-01 Cable Assembly Notes	16
Table A-2: J2 DB26 Pin-Outs.....	16
Appendix B Setting eNet-1553 Static IP V4 Address	17

eNet-1553 Hardware Manual

Introduction

This manual provides detailed hardware information on the eNet-1553 interface product.

In addition to this information, the reader may also want to reference the following documents provided on the CD and our Web Site

- **AltaCore™** Specifications and User Manual: Detailed description of the 1553 protocol engine of the card. Most people do not need this detail and will mainly reference the **AltaAPI** manual for their application development.
- **AltaAPI™** User's Manual: Detailed description of the application program interface (API) and device drivers of this software package.
- **AltaView™** User's Manual: AltaView is the latest 1553 analyzer on the market and this manual details the usage of the product.
- **AltaRTVal™** User's Manual: This manual details the usage of AltaRTVal, which is an automated program to run AS4111/4112 RT Validation and Production Test Plans.
- 1553 Tutorial and Reference, and 1553B Standard. These documents provide a detailed review of the 1553 standard, which is required for proper usage of this product. **SEE THIS DOCUMENT FOR WIRE & CABLING INFORMATION OF 1553 BUSES – THIS IS REQUIRED FOR PROPER BUS OPERATIONS.**

ESD and General Handling of Computer Interface Cards

The Alta warranty requires that the product be handled with proper ESD controls. The JEDEC standard on ESD handling, JESD625, is available for free download at www.jedec.org. Please follow the standard's guideline for proper ESD handling methods. At a minimum the following guidelines should be followed:

- Avoid carpets in cool, dry areas.
- Leave the card in its anti-static packaging until ready to be installed.
- Dissipate static electricity before handling the card by touching a grounded metal object, such as the metal chassis of the system (the system should be plugged-in, but turned-off).
- Use antistatic devices, such as wrist straps and floor mats.
- Always hold the card by its edges. Avoid touching the components or connectors.
- Be sure to align card edge or assembly cable connector pins before installation. Misaligned connectors can cause damage to the card or system, especially at power-on.
- Take care when connecting or disconnecting cables. When disconnecting a cable, always pull on the cable connector, not on the cable itself.



eNet-1553 Description

eNet-1553 is an innovative product that provides “remoting” of 1553 operations on 10/100/1000 Ethernet IP/UDP local area networks (LAN). eNet-1553 is a small, low-power, rugged device that provides connectivity for one dual redundant 1553 bus and is ideal for remoting 1553 connections for in-field applications or point-point lab usage.

Alta has combined the industry's most advanced 32-bit 1553 FPGA protocol engine, **AltaCore™**, with a real-time IP/UDP thin server. The customer can implement their application with the same feature-rich application programming interface, **AltaAPI™**, which is a multi-layer ANSI C and Windows.NET (MSVS C++, C#, VB .NET) architecture. This hardware and software package provides increased system performance and reduces integration time.

Card Level Specifications

- 10/100/1000 Ethernet
- Supported protocols are UDP and ARP
- Programmable IP address: **Default IP address is 192.168.0.128**
- One MIL-STD-1553 Channel
 - Transformer Coupled Stub Interface Standard
 - Direct Coupled Stub Interface available upon request
- 1 Mbyte of on-board memory
- IRIG-B Receiver (DC or AM)
- Signal Capture capability
- 6 Single-Ended Bi-Directional Avionics Discretes
- Two RS-485 Discretes
- One LVTTTL Input and Output Trigger
- External Input and Output Clocks (LVTTTL or RS-485 Selectable)
- 1760 Ext RT Addressing
- Two Temperature Sensors
- Auto Load BC, RT and BM Images for Fast Startup
- Auto BM Mode for 1553->Ethernet Bridging
- 5-32 VDC Conditioned Power
 - Lab Use 5V USB Power 1 AMP Typical
 - Embedded applications, use conditioned power source
 - Power Over Ethernet (POE) Optional*
 - Reverse Polarity Protected to 40 Volts
- 4.5 Watts Max (100% Bus Loading)
- 205g Weight
- Operating Temperature range:
 - 0 to +70C Standard
 - -40 to +85C Extended Temp Parts with -E Option (as applicable).
 - ***Note: The eNet-1553 device cannot operate at extended temperature range when the POE option is in use. When using POE, it should only operate in the 0-70C Standard Range.**
- Relative humidity: 5 to 95% (non-condensing).
- RoHS Compliant

Power Specifications

Table 1. Idle Power

IDLE			
Channel	Input Voltage (V)	Current (A)	Total Power (W)
N/A	5	0.5	2.5

Table 2. 50% Bus Loading Power

50% Bus Loading			
#Channels	Input Voltage (V)	Current (A)	Total Power (W)
1	5	0.71	3.55

Table 3. 95% Bus Loading Power

95% Bus Loading			
#Channels	Input Voltage (V)	Current (A)	Power (W)
1	5	0.89	4.45

The power shown above is for a 1000Mbps link. 100Mbps operation is approximately 100mW under 1000Mbps. 10Mbps power is slightly under 100Mbps, but this operation is not recommended.

eNet-1553 Power and Ethernet Speed Negotiation:

At least 1000 mAmp @ 5 VDC available power is recommended for eNet-1553.

Alta's optional J1 cable (ENETCAB-1553-J1-01) provides a USB connector for power source. Most computers/USB power adapters provide enough power, but some only provide ~500 mAmps and this will not allow eNet-1553 to negotiate to 1000 Ethernet (as gigabit Ethernet draws extra power: about 300-400 mAmps). If using USB power, make sure it can provide at least 1000 mAmp of power (there are many low cost USB-AC power adapters that provide 1000 or 2000 mAmp of USB 5V power).

For non USB power connections, make sure to provide 4.5 watts of 5-32 VDC of power.

MTBF

Please contact your Local Sales Representative or Alta Technical Support for additional information regarding any concerns or questions that may arise regarding MTBF for this product.

Environment: Ground Benign, 25C

Table 4. MTBF

eNet-1553	
MTBF	674,732 hrs

eNet-1553 Photograph

The following picture shows the front side of the eNet-1553 product.



Figure 1. eNet-1553 Front Side

LED Descriptions

Table 5. LED Descriptions

Name	Description
PWR BIT	Green = Power On, FPGA Loaded and No Bit Errors Detected Green Blinking = IRIG lock is detected. Blinks at 1sec intervals. Red = Power On, FPGA Loaded and Bit Errors Detected, or Factory Reset Asserted
ETH LNK	Green = Ethernet Link Detected Red = No Ethernet Link Detected
ETH ACT	Green= Ethernet Activity Detected without Error Red = Ethernet Activity Detected with Error
BUS ACT	Green= 1553 Activity Detected without Error Red = 1553 Activity Detected with Error

See Appendix A for J1 and J2 Connector and Optional Cable Information.

eNet-1553 Dimensions

The following figure provides the dimensions of the eNet-1553 product. All units are in millimeters.

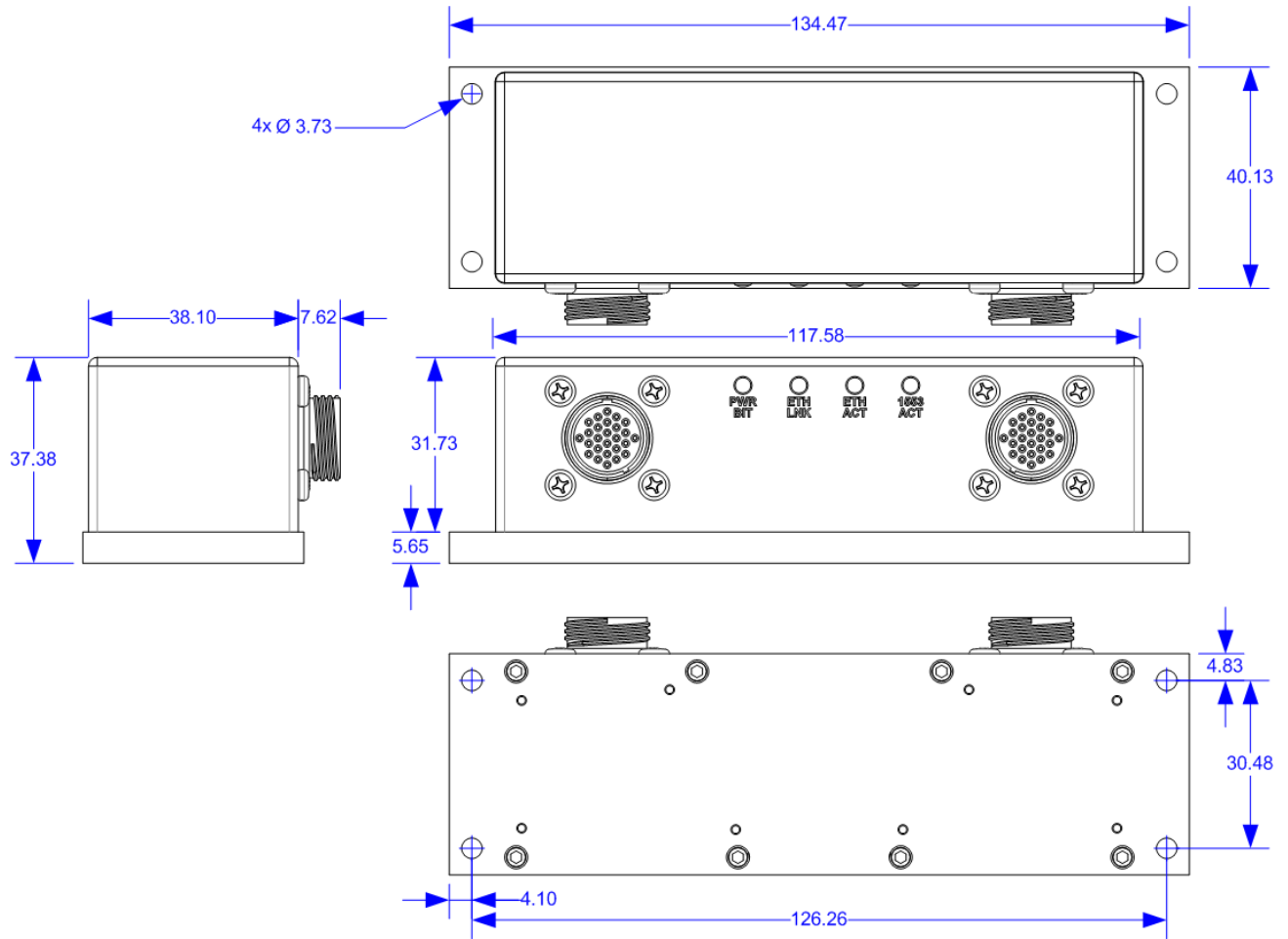

Figure 2. eNet-1553 Dimensions (mm)

Factory Default IP V4 Address

The factory default IP V4 address for eNet-1553 is **192.168.0.128**. This value can be re-programmed/flushed by the user as needed for their LAN settings (see Appendix B). Once changed, it is recommended that the user label/tag/record the unit's new IP address for future reference.

How to Reset IP Address to Factory Default

It can be useful to reset the eNet-1553's IP address back to the factory default (see above) if you have forgotten the device's address (or for other reasons).

To reset eNet-1553's IP address to the factory default, connect the **~FACTORY IP RESET** pin on the J2 connector **to ground** (see Appendix A) **prior to powering up the unit**. Upon power up with the pin grounded, the device will temporarily have the factory default IP address and the PWR BIT and ETH LNK lights glow **red**. Keep the pin grounded and now reprogram/flash to a new permanent address per Appendix B (even if you want to keep the 192.168.0.128 default value).



NOTE: When the ~FACTORY IP RESET signal is active (pulled low - grounded) this puts the eNet-1553 product in programming mode only. The 1553 channel will not be operational in this mode.

MAC Address:

The MAC address for the eNet-1553 consists of the unique Alta OUI identification number and the serial number of the product.

The first 3 bytes contain the Alta OUI identifier: 94:9C:55

The last 3 bytes contain the last 5 digits of the product serial number in hex.

Example Mac address for eNet-1553 Serial Number 1104-00211:

94:9C:55:00:00:D3 (where 211 decimal equals D3 hex)

Signal Capture Discussion

The eNet-1553 HW provides Signal Capture capability on Channel One.

1553 Signal Capture:

The Signal Capture feature uses an analog-to-digital converter (ADC) to capture the electrical signal on the selected 1553 stub (A or B). The Signal Capture feature will capture 2048 samples at a rate of 20MHz, or 50 nanoseconds per sample. Therefore, the sample buffer contains 102.4 microseconds of data. Each sample is an 8-bit (256 step) value representing the differential voltage on the 1553 stub.

To convert the raw ADC data to a stub voltage representation, use the following formula:

$$\text{Stub Voltage} = (\text{ADC data} - 128) * 1.79 \text{ (xformer ratio)} * 32 \text{ (voltage divider)} * 2\text{mv (step voltage)}$$

Reducing the above gives:

$$\text{Stub Voltage} = (\text{ADC data} - 128) * 0.11456$$



WARNING: The Signal Capture data should be accurate to within 500mV. The Signal Capture Feature does NOT replace a calibrated oscilloscope for voltage or timing measurements on the 1553 stub. The Signal Capture Feature provides simple voltage and timing data. If more precise information is needed regarding the electrical signal on the 1553 bus, a real oscilloscope should be used.

The following steps should be performed to acquire Signal Capture data from the PE. See the [AltaCore-1553 User's Manual](#) for more information on the Signal Capture CSR and Data Registers.

1. Set the Trigger on Any Activity bit in the Signal Capture CSR
2. Wait for Data Ready bit to get set in the Signal Capture CSR
3. Read data from the Signal Capture Data Register. Note: The Data Register contains four samples.
4. Keep reading data until the FIFO Not Empty bit is set to zero by the PE.

Host Memory Map

The figure below shows the basic memory map configuration for a one channel eNet-1553 interface with one megabyte of RAM per channel. Special configurations may vary.

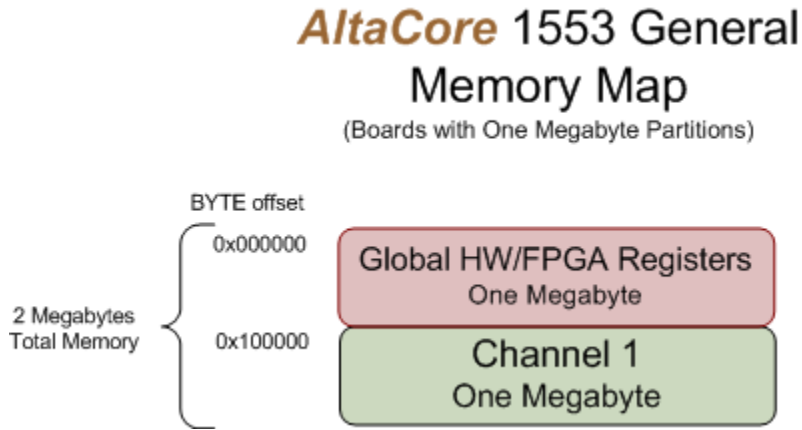

Figure 3. Basic Memory Map

eNet-1553 Global Registers

The first Megabyte of the eNet-1553 memory map contains backplane and global card level settings and status values that affect processing for all channels. Details on Global Registers may be found in the AltaCore-1553 Spec User's manual.

Revision Information

Date	Rev	Description
05/03/2011	A0	Initial Release
11/15/2011	A1	Added Appendix B and USB Power Note
02/05/2012	A2	Updated power information under card level specifications
07/25/2013	A3	Fixed Ethernet signal names in J1 connector table
08/20/2014	A4	Updated card level specs for power & weight. Changed TX INH to show active low. Updated J2 cable table & cable names. Updated MTBF based on new part library data.
11/10/2014	A5	Updated Alta PN for mating connectors
10/12/2015	A6	Updated pin-out table
02/10/2016	A7	Added Blinking to PWR/BIT LED, changed bus activity to transmitting in power chart, and various typos.
01/31/2017	A8	Updated cable information to include whether or not cables contain PVC
05/09/2017	A9	Updated Signal Capture Discussion
08/16/2018	A10	Changed default IP address listed in Appendix B, Step 2 from 192.169.0.128 to correct 192.168.0.128
10/30/2018	A11	Updated file name in Appendix B and updated pictures
03/02/2021	A12	Updated LED PWR BIT description (table 5) to include factory reset asserted and updated Card Level Specifications on pg.3 to include Reverse Polarity Protection
01/17/2023	A13	Updated Card Level Specifications, NAICS #, contact info and PWR table Removed revision and date from boards description

Appendix A

eNet-1553 Connectors and Cable Assembly Information

J1 and J2 Connector Information – Alta & Glenair (GA) Part Numbers

<http://www.glenair.com/index.htm>

26-Pin Connectors are Keyed with “A” or “B” pattern. J1 uses the A pattern.

- **J1 Jack:** Glenair 801-011-02M10-26SA Female
 - **Glenair Mate/Male Part Number: 801-007-16M10-26PA**
 - Alta J1 Mate Part Number: ENETCON-J1-01
- **J2 Jack:** Glenair 801-011-02M10-26SB Female
 - **Glenair Mate/Male Part Number: 801-007-16M10-26PB**
 - Alta J2 Mate Part Number: ENETCON-J2-01
- Dust Cover Plug (probably only needed for J2, but works with either connector):
 - **Glenair Part Number: 667-218-M-N10**
 - Alta Mate Part Number: ENETDCAP-J2-01



J1 and J2 Pin-Out Table

J1 Pin-Out	Signal	J2 Pin-Out	Signal
1	ETHERNET BI_DA+	1	SDISC1 / RTADDR_1
2	DC POWER IN +	2	SDISC3 / RTADDR_3
3	ETHERNET BI_DA-	3	SDISC2 / RTADDR_2
4	1553 CH 1A+	4	SDISC6 / RTADDR_P
5	GND	5	SDISC5 / RTADDR_5
6	ETHERNET BI_DB+	6	SDISC4 / RTADDR_4
7	GND	7	GND
8	N/C	8	GND
9	1553 CH 1A-	9	DDISC2+ (RS-485)
10	JTAG 3.3V OUT	10	TRIGGER IN
11	ETHERNET BI_DB-	11	DDISC1+ (RS-485)
12	1553 SHIELD \ CHASSIS GND	12	DDISC2- (RS-485)
13	GND	13	GND
14	N/C	14	GND
15	GND	15	DDISC1- (RS-485)
16	1553 CH 1B+	16	N/C
17	JTAG TDI	17	TRIGGER OUT
18	ETHERNET BI_DC+	18	GND
19	JTAG TDO	19	~EXT RT ADD ENABLE
20	JTAG TRST	20	TX INHIBIT
21	1553 CH 1B-	21	IRIG IN
22	JTAG TMS	22	GND
23	ETHERNET BI_DC-	23	~FACTORY IP RESET
24	JTAG TCLK	24	GND
25	ETHERNET BI_DD+	25	GND
26	ETHERNET BI_DD-	26	EXT CLK I/O – TTL I/O

Optional J1 and J2 Cable Assemblies

eNet-1553 has two Glenn Air circular connectors labeled J1 (left-most) and J2 (right-most). Connector part numbers and pin-outs are provided in the eNet-1553 hardware manual. Alta provides optional cable assemblies for these connections and their part numbers are:

- **ENETCAB-1553-J1-01** (J1 with one 1553 channel**)
- **ENETCAB-J2-01** (J2 cable assembly**)

Both cables are IPC-610 Class 3/RoHS.

* Does not contain PVC

** Contains PVC

The ENETCAB-1553-J1-01 assembly is show below:

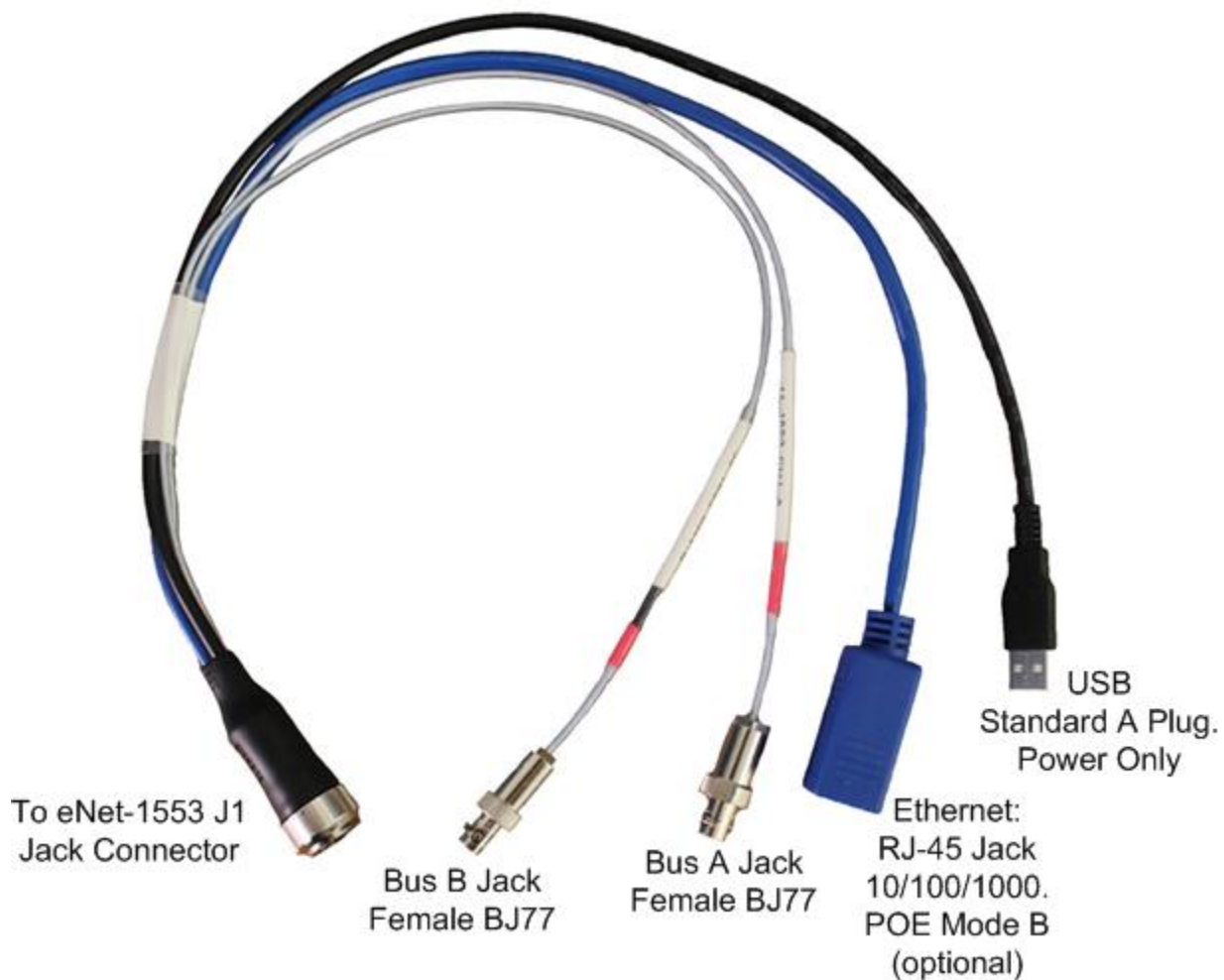
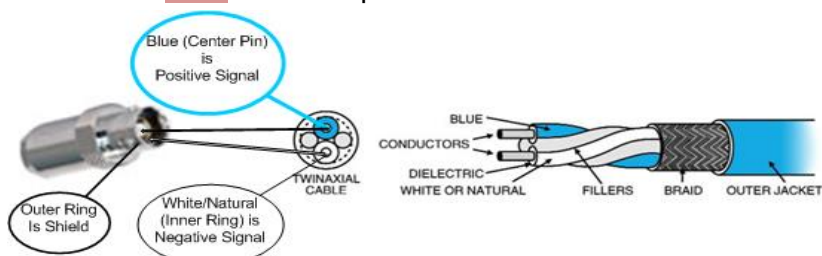

Figure A-1: Optional ENETCAB-1553-J1-01 Cable Assembly

ENETCAB-1553-J1-01 Cable Assembly Notes:

- **Cable Length: Approximately 2ft**
- **Cable Assembly P1 and Part Number Label Approximately 2” from Base**
- **1553 Connectors are 3-Lug (BJ-77 Type) Female Connectors**
 - ~1” from Connector Base Label: Cable Part Number
 - CH1 A – Shrink Tube Color Code: **Red**
 - CH1 B – Shrink Tube Color Code: **Red-Black Stripe**



- J1 1553 CH1 A
- J2 1553 CH1 B
- 1553 thin MIL Cable

- **Ethernet RJ45 Jack**

- Depending on your computer, you may need a Cross-Over Cable Per T568B. Most computers auto negotiate and standard Patch Cables work. Recommend the following references:

- http://en.wikipedia.org/wiki/Ethernet_physical_layer
- **CAT 6 CABLE STRONGLY RECOMMENDED**
- Straight-Through Ethernet Cable Pin Out for T568B Per Table:

RJ45 Pin #	Wire Color (T568B)	Wire Diagram (T568B)	10Base-T Signal 100Base-TX Signal	1000Base-T Signal
1	White/Orange		Transmit+	BI_DA+
2	Orange		Transmit-	BI_DA-
3	White/Green		Receive+	BI_DB+
4	Blue		Unused	BI_DC+
5	White/Blue		Unused	BI_DC-
6	Green		Receive-	BI_DB-
7	White/Brown		Unused	BI_DD+
8	Brown		Unused	BI_DD-

Table A-1: Over-Molded Ethernet RJ-45 Jack Pin-Outs

- **USB Standard A Plug Connector (fits most computer USB jacks).**

Power Only (“Functional Decoration” Device).

- Recommend >1000 MA source, which is common on most computers, but low-end wall adapters may not provide enough power (recommend wall adapter ratings at 2000+ MA).
- Pin 1 +5 Vcc; Pin 4 Ground; Data Pins 2 & 3 Not Connected

The ENETCAB-J2-01 assembly is show below:

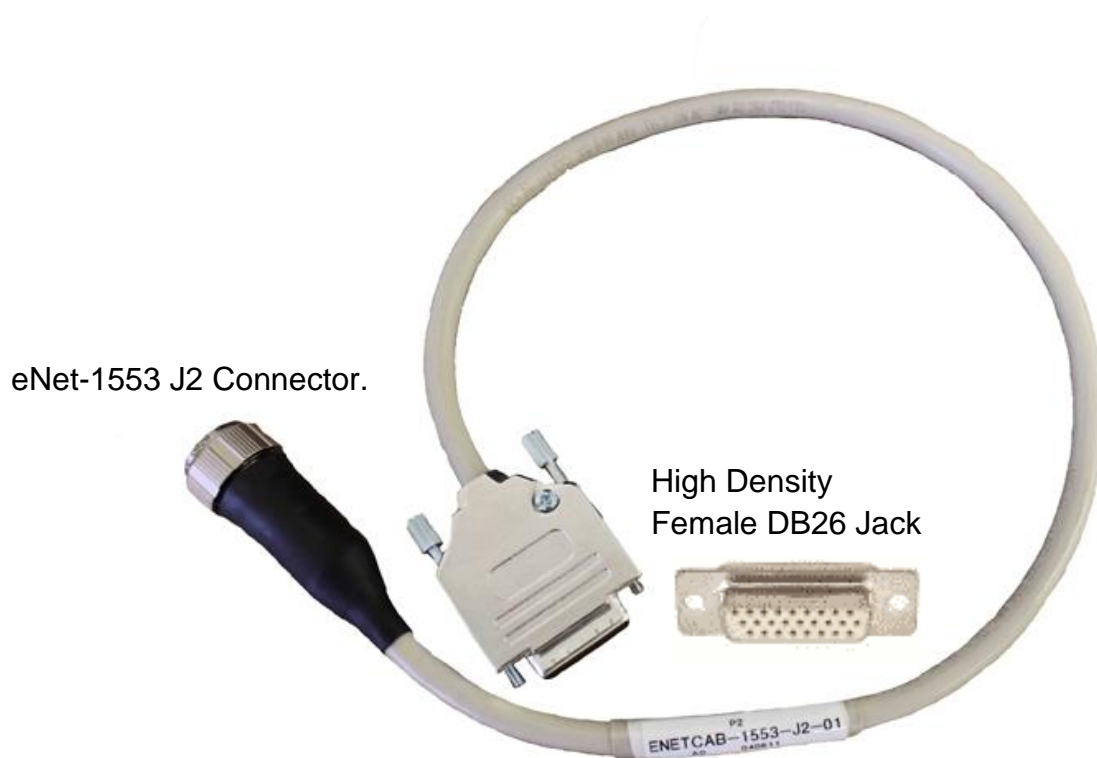

Figure A-2: Optional ENETCAB-J2-01 Cable Assembly

ENETCAB-J2-01 Cable Assembly Notes

- **Cable Length: Approximately 2ft**
- **Cable Assembly Part Number Label Approximately 2” from Base**
- **J1 DB26 Female High Density Connector** (Pin Numbers Marked on Connector)
 - ~1” from DB Connector - J1 Label

J2 Circular Pin	Signal	Cable Color	DB-26
1	SDISC1 / RTADDR_1	Blue/Green	1
2	SDISC3 / RTADDR_3	Yellow/Green	3
3	SDISC2 / RTADDR_2	Green/Blue	2
4	SDISC6 / RTADDR_P	Green/Yellow	6
5	SDISC5 / RTADDR_5	Brown/Green	5
6	SDISC4 / RTADDR_4	Green/Brown	4
7	GND	Black/Red	7
8	GND	Black/Blue	11
9	DDISC2+ (RS-485)	Green/White	15
10	TRIGGER IN	Red/White	8
11	DDISC1+ (RS-485)	Green/Red	12
12	DDISC2- (RS-485)	White/Green	16
13	GND	Red/Black	14
14	GND	White/Red	17
15	DDISC1- (RS-485)	Red/Green	13
16	N/C	Black/Yellow	18
17	TRIGGER OUT	Blue/Black	10
18	CHASSIS GND	Shield	Case
19	~EXT RT ADD ENABLE	Yellow/Black	19
20	~TX INHIBIT	Brown/Black	20
21	IRIG IN	Blue/Red	21
22	GND	Red/Blue	22
23	~FACTORY IP RESET	Green/Black	23
24	GND	Black/Green	24
25	GND	Black/Brown	26
26	EXT CLK I/O – TTL I/O	Black/White	25

Table A-2: J2 DB26 Pin-Outs

Appendix B

Setting eNet-1553 Static IP V4 Address

The eNet-1553 device has a factory default IP V4 address of 192.168.0.128 (class.class.subnet.hostNum) loaded in the boot-up flash. Many customers need to change this address to match their computers or LAN IP settings (especially subnet). Changing the eNet-1553's IP address in boot-up flash is reviewed in this Appendix.

The customer has two options to change the IP address: Use the AltaView application for Microsoft Windows™, or compile and execute a C sample program provided on the CD/Web distribution in the "Examples" "M1553" folder (this option is needed for Linux, VxWorks or other non-Windows systems). Even for non-Windows environments, it may be easier to find a Windows machine and make the address change prior to installing eNet-1553 on your Linux/Other/LAN environment.

Alta can also preset the IP address for you at the factory. This may entail a special part number for re-order tracking, but we would be glad to help if you need the device's address programmed or preset. Contact Alta at alta.support@altadt.com

Windows Systems

The following paragraphs apply only to Windows machines using AltaView to update the IP Address, but Linux/Unix/Other users may want to briefly review. Non-Windows users will need to read their respective Appendix in the AltaAPI manual for their OS and will then need to compile/execute the example program

[ADT_L1_Global_ex_eNet_Set_IP.c](#). **You will need to set your local computer's IP address to match the 192.168.0.X class.class.subnet settings of eNet-1553's default to communicate to the device (X = host number and can be anything other than eNet-1553's default value of 128).**

STEP ONE: Set your Windows Computer's Static IP V4 Address to Match eNet-1553's class.class.subnet Values.

IT IS RECOMMENDED TO TURN OFF WIRELESS DEVICES ON THE CLIENT COMPUTER WHEN USING eNet-1553. Windows OS can send packets on different network interfaces, so you should turn off all network connections except the wired device that is connected to eNet-1553. You can also HARD SET the Windows Routing Table for eNet-1553 IP routing, but this is beyond the scope of this discussion (google: Setting Windows IP Routing Table).

There are numerous web sites that detail how to set your Windows machines IP address to a static value. Simply google: Setting a Static IP address in Windows.

Here are general instructions (do not have eNet-1553 connected to your computer yet).

1. Open the "Start" menu and click Control Panel. Click the "Network and Internet" link, then the Network and Sharing Center link. Click the "View network connections" link to see your adapters.
2. Right-click on the adapter you want to change and choose "Properties" from the list. Click once on "Internet Protocol Version 4 (TCP/IPv4)" to select it and then click the "Properties" button. Click the radio button for "Use the following IP address:" and enter the static IP address you'd like to use in the IP address box.
 - a. **IP Address Example: 192.168.0.10**
(This will match eNet-1553 Default Subnet)
3. Hit "Tab" when you are finished and the "Subnet mask" value should auto-fill with the proper value. You should not need to set any other values (like gateway – leave blank).
 - a. **Example SubNet Mask: 255.255.255.0** – Should Auto Fill In
4. Click "OK" to save your changes, then click "OK" again on the Local Area Connection Properties window.
 - a. You can verify your computer's setting by right-clicking on the "Local Area Connection" device and selecting "Status" -> "Details"
5. **Now Connect eNet-1553 to your computer using a standard Ethernet CAT6 patch cable.** (CAT5 will probably work, but we recommend CAT6 – **a cable is provided in the eNet-1553 shipment box**).
6. Optional: Now you can communicate to eNet-1553 using AltaView or the C example programs.

Windows Example for Setting Static IP V4 Address

Program Windows Static IP Address on Windows 7 (right click on Local Area Connection, Network 4 in this example, and select properties). When **Internet Protocol Version 4** is selected, the **Properties** button should brighten and be selectable.

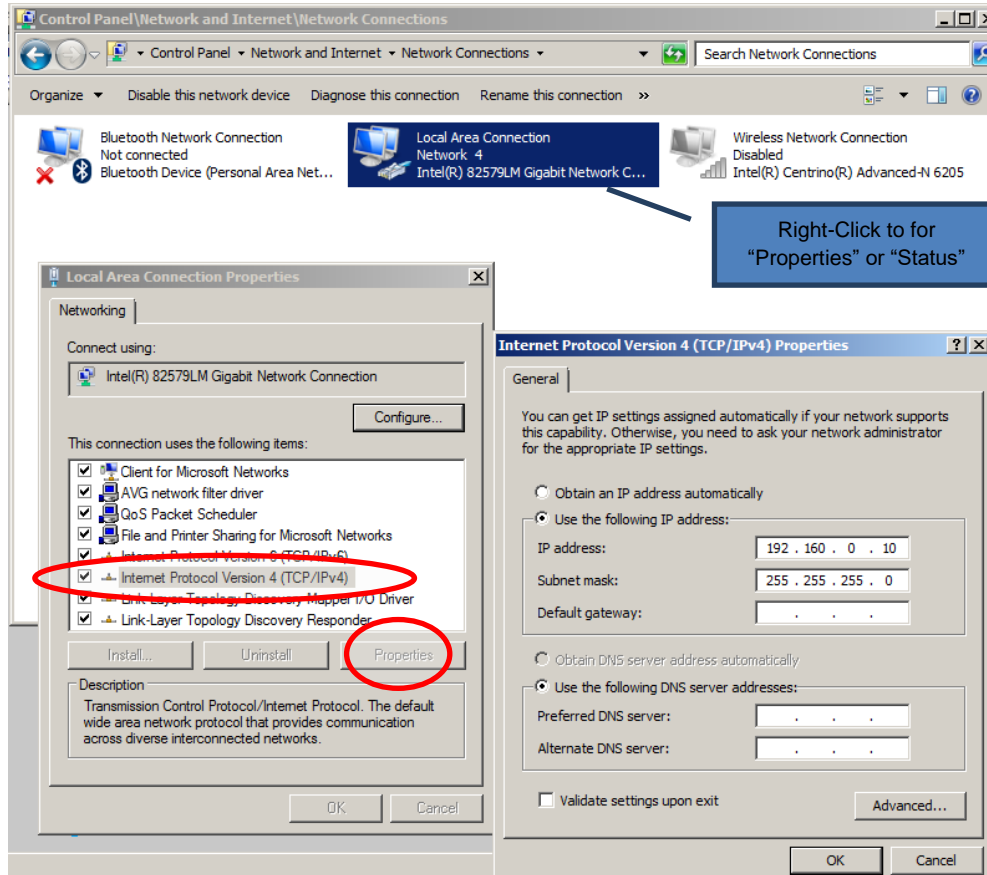

STEP TWO: Use AltaView to Set eNet-1553 IP Address.

With the latest Alta software installed on your computer, perform the following steps:

1. Open AltaView
2. Click on **Alta Logo Button** and Select **“Open Device”**
 - a. On the right-middle pull down menus, select from default:
Board Type: ENET-1553
Channel Type: Global
3. In the lower right **Network Options** area, make sure the “ENET DEVICE (Server)” and “This System (Client)” IP Address are correct. The ENET Server IP address should be default 192.168.0.128 and your computer’s Client address should be 192.168.0.X, where X is anything but 128 (eNet-1553’s host number address).
 - a. If you can’t select your Client’s IP address to the proper subnet value, then you have a problem with setting the computer’s static IP address. Go back to Step One or contact your administrator for help. You need to verify that the Local Area Connection device is set to the proper 192.168.0.X static IP address.

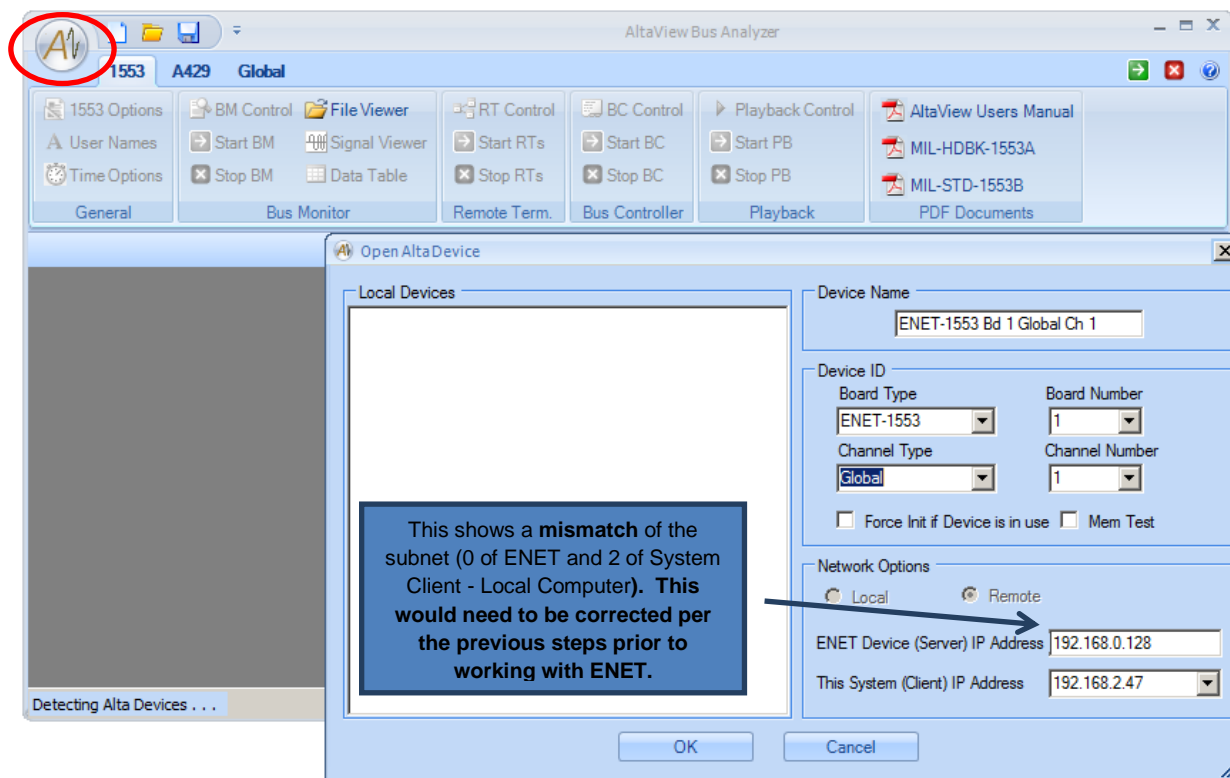

4. Once you get the IP addresses (and subnet) all matching, and the patch cable is connected, then you should successfully open the “Global Ch 1” device.
 - a. In the Device Window you should see **Status Initialized**
5. Now you can Click on **Global** Tab (next to 429) and then select **ENET Config**.
6. Then simply set the New IP Address and click OK (do not set APMP at this time unless you want to enable auto BM APMP – not reviewed here).
7. There should be short pause and then you will get a SUCCESS Window followed by a COMPLETE window. Close AltaView if you want.
 - a. NOW CYCLE POWER on the eNet-1553 device and it should be ready for use with the new IP Address. If you mess up, no worries, you can reset the address to the factory default by grounding the J2 connector pin ~FACTORY IP RESET. See the previous section of this manual for pin-out info.
 - b. You probably want to set your computer’s IP address back to another value or back to DNS (auto IP addressing).

